

A77

6百萬畫素 室外半球型 具備 日夜兩用, IR, 超
高級 寬動態, SLLS, 定焦鏡頭



- 6 百萬畫素
- 日間及夜間 具備 優越級 低照度感測 和 紅外線
- 定焦鏡頭 with f2.8毫米/F1.6
- 超高級 寬動態
- 超廣角
- 臺灣影像監控系統資安標準 1 級標章 (TAICS)
- 事件觸發、回應和通知

► 規格

功能

類型	半球型
最高解析度	6百萬畫素
應用環境	戶外
影像傳感器	逐行掃描的CMOS
傳感器尺寸	1/2.7 "
有效像素	3864(水平) X 2192(垂直) (8.46 百萬畫素)
日夜模式	有
低照度感測	優越級
最低照度	彩色: 0.003 Lux; 黑/白: 0 Lux (IR LED開啟)
機械紅外濾鏡切換	有
紅外線	紅外線 x 3 (850 nm)
紅外燈照射距離	65公尺
電子快門	1/5-1/100000 秒 (自動模式)
信噪比	75 dB

鏡頭

焦距	定焦, f2.8毫米
光圈	F1.6
光圈	固定光圈
焦點	定焦
鏡頭卡口	板載
水平可視角度	103.6°
垂直視角	56°
視角調整	平移: 0°-355°, 傾斜: 0°-75°, 旋轉: 0°-355°

影像

分辨率	H.265 Adaptive Stream (equivalent to Zip or Smart Stream or H.265+), H.264 Adaptive Stream (equivalent to Zip or Smart Stream or H.264+), MJPEG
最大幀率和分辨率	20 幀 3200 x 1800 20 幀 3072 x 2048 20 幀 2592 x 1944 30 幀 2688 x 1520 30 幀 2560 x 1440 30 幀 1920 x 1080 30 幀 1280 x 960 30 幀 1280 x 720 30 幀 640 x 480
多串流	提供4串流
比特率模式	常數, 可變動
寬動態	超高級 寬動態 (150 dB)
影像升級	白平衡, 亮度, 對比, 銳利度, 飽和, 背光補償, Strong Light Suppression
數位降噪	2D + 3D DNR
隱私遮擋	4 配置區域
文字疊加	Yes
圖片覆蓋	Yes
內建分析	Deep Learning : 人臉偵測, 破壞偵測, 物體移動偵測, 電子圍籬, 進入區域, People Line Crossing Detection, People Enter Area Detection, Vehicle Line Crossing Detection, Vehicle Enter Area Detection
影像定位	翻動, 鏡面, 旋轉 (走廊模式) (90°, 180°, 270°)

音頻

音頻類型	雙向, 外部音源輸入, 外部音源輸出
音源壓縮	脈衝編碼調變, G.711, AAC(*3), G.726(*3)

網路

網路協議與服務	IPv4, IPv6(*3), TCP, UDP, DHCP, PPPoE, HTTP, HTTPS, DNS, DDNS, NTP, RTP, RTSP, RTCP, SMTP, FTP, SFTP, IGMP, ICMP, UPnP, QoS, SNMP, IEEE 802.1X
網路埠口	1 x 乙太網路(10/100 Base-T), RJ-45 pigtail 連接埠
安全	IP 位址過濾, HTTPS 加密, 密碼保護用戶級別, 匿名登入, IEEE 802.1X 網路門禁控制, Standard IoT Security (anti-hacking, anti-malware)

事件功能

事件觸發	Video motion detection (4 polygonal regions with up to 10 vertices), 透過數位輸入連接外部設備, 智能事件偵測, 聲音的檢測, 影像串流中斷, System log buffer overrun, Remove system log, Logon events (Login Failure, Login Success, Block an Account)
------	---

事件回應

通知中控制中心, 變更攝影機的設置, 指揮其他設備, E-mail 通知與快照, 播放聲音檔, 推播通知至行動裝置, Save video to local storage, Upload video to NVR server, 上傳影像或快照到FTP伺服器, 透過數位輸出觸發外部設備

系統

系統監測	CPU 使用率, 記憶體使用量, 網路流量資訊 (內建網頁伺服器, 提供API讀取系統狀態)
System Log	支援
看門狗	支援

整合

整合解決方案	與ACTi的軟體完全相容
GPS 位置	手動設定
Edge Recording	支援 (integration with NVR by ONVIF Profile G or proprietary protocol)(*2)
ONVIF 標準	有, Profile S, Profile G, Profile T, Profile M
支援瀏覽器	IE 11, Google Chrome*, Microsoft Edge*, Apple Safari*
韌體線上更新功能	有

界面

本地儲存	MicroSD, MicroSDHC, MicroSDXC Memory Card Slot (card not included, up to 256GB, Kingston or Sandisk only)
數位輸入/輸出	1/1 (端子台)
Operating Button	復位按鈕

一般

電力來源	直流電(DC) 12V, PoE 等級 3 (符合 IEEE802.3af)
電源消耗	7.5 W (PoE)
尺寸	(Ø x H): 110.82毫米 x 84.7毫米 (4.36" x 3.33")
防護罩等級	防水 (IP68), 防暴 (IK10)
Corrosion Protection	可選的專案需求. Chassis corrosion resistance at the seashore approximately 2-3 years.
安裝方式	Wall Mount, Pole Mount, Pendant, Flush, Gang Box
操作溫度	-40溫度(攝氏) ~ 60溫度(攝氏) (-40溫度(華氏) ~ 140溫度(華氏))
認證	CE Class B, FCC Class B, IP68, IK10, UL Listed, 臺灣影像監控系統資安標準 1 級標章 (TAICS)
彩色	白色
實時時鐘 (RTC)	有
保固	3 年. 有關延長保固期, 請見 http://www.acti.com/support/warranty
備註	* cross-browser compatibility: Not available for H.265 video decoding *2 Edge Recording function is integrated with NVR 3 Corporate / NVR 3 Business / INR / GNR series. *3 讓未來的韌體可順利更新

▶ 產品圖片

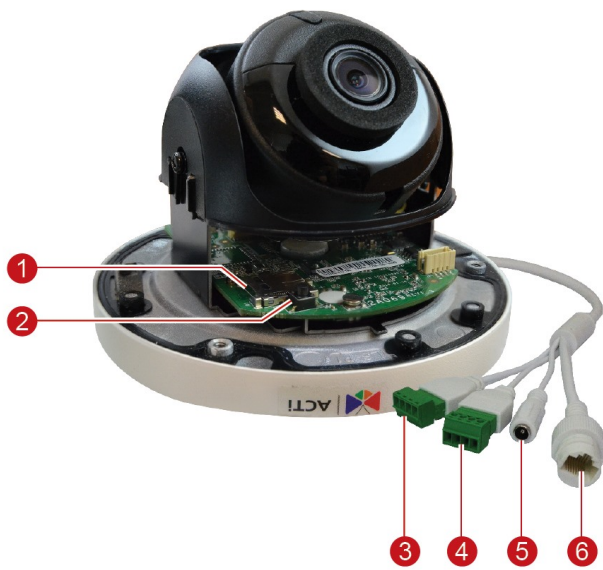

- ① 記憶卡插槽
- ② 復位按鈕
- ③ 音頻輸入 / 輸出
- ④ 數位輸入/輸出
- ⑤ DC 12V 電源輸入
- ⑥ 網路埠口

▶ 尺寸圖片

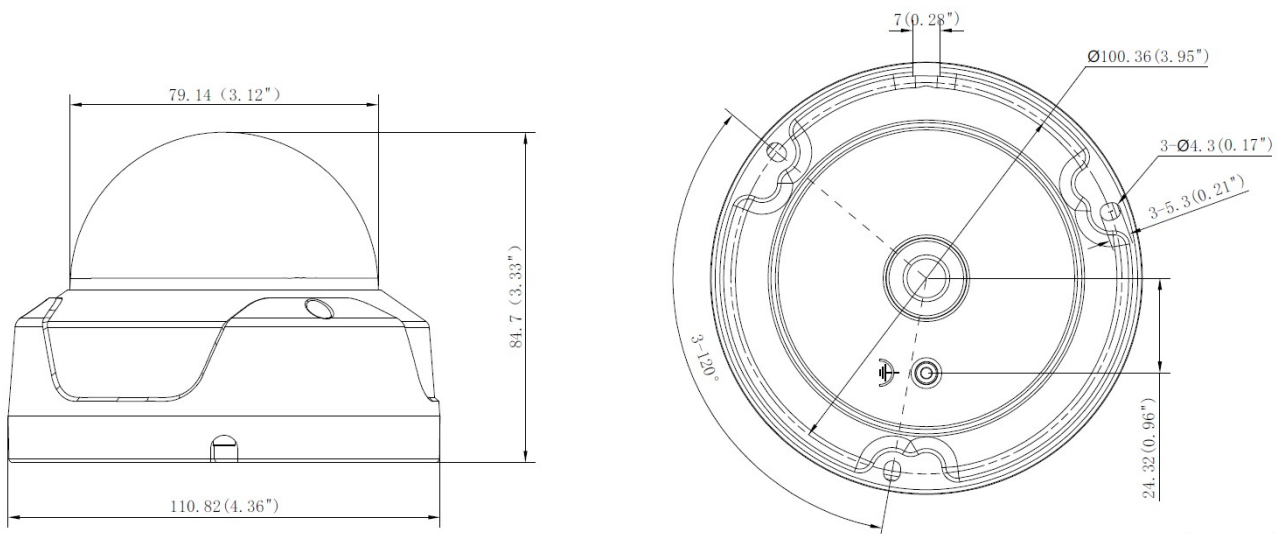













Unit: mm(inch)

單位: 毫米 [英寸]

▶ 相關產品

安裝配件 - 攝影機支架

PMAX-0122		Straight Tube (for A71, A88, A9x,)
PMAX-0123		Extension Tube (for A71, A88, A9x,)
PMAX-0128		Pendant Mount (for Z85, Z86, Z87, Z810)
PMAX-0318		Wall Mount (for Z91, Z97, Z98, Z710, Z714, Z715, A71, A76, A77)
PMAX-0323		Wall Mount with Built-in Junction Box (for Z91, Z94, Z95, Z97, Z98, Z77, Z81, Z82, Z85, Z86, Z87, A7X)
PMAX-0506		Pole Mount (for A31, A4x, E78, E9x, E9xx), supports 2" to 3" Poles
PMAX-0527		Pole Mount (for Z4x, Z710, Z8x, Z9x, A7x), supports 2.64" to 5" Poles
PMAX-0532		Pole Mount (Z710, Z8x, Z9x, A7x), supports 2.6" to 5" Poles
PMAX-0718		Junction Box (for A71, A74, A77)
PMAX-0816		Converter Ring, 1.0" NPT for Third-Party Mounting Accessories, White
PMAX-0820		Gang Box Converter (for A71, A74, Z91, Z94, Z95), supports 4" Round and 4" Octagon Boxes
PMAX-1032		Flush Mount (for A71, A74, A77, E78, E79, E710)
PMAX-1402		Mount Kit (for Z91, Z97, Z98, Z710, Z714, Z715, A71, A76, A77)

備註: 某些安裝附件可能需要額外的附件才能安裝。請訪問網站了解更多信息 - www.acti.com/mountingselector

電源供給配件 - 電源變壓器

PPBX-0013		Power Adapter AC 100~240V (EU), for A3x, A4x, A88, A9x, Z31, Z8x, Z9x
PPBX-0014		Power Adapter AC 100~240V (UK), for A3x, A4x, A88, A9x, Z31, Z8x, Z9x
PPBX-0026		Power Adapter AC 100~240V (US), for A3x, A4x, A7x, A88, A9x, Z3x, Z4x, Z7x, Z8x, Z9x

音頻設備 - 麥克風

PMIC-0100



Active Microphone Omnidirectional for all Cameras with Line-in Audio