

## 198

2百萬畫素 室外全功能攝影機 具備 日夜兩用, 智能型紅外線, 超高級 寬動態, ELLS, 33x 變焦鏡頭



- 2 百萬畫素
- 日間及夜間 具備 超高級 低照度感測 和 智能型 IR LED
- 33x 自動變焦鏡頭 with f4.5-148.5毫米/F1.55-F5.0, DC 光圈, 自動對焦
- 超高級 寬動態
- Overview, Zoom and Tracking (OZT)
- 臺灣資安標準 2 級標章 (TCA)
- 事件觸發、回應和通知

## ► 規格

### 功能

類型	全功能攝影機
最高解析度	2百萬畫素
應用環境	戶外
影像傳感器	逐行掃描的CMOS
傳感器尺寸	1/2.8 "
有效像素	1944(水平) X 1224(垂直) (2.38 百萬畫素)
日夜模式	有
低照度感測	超高級
最低照度	彩色: 0.002 lux at F1.55 (30 IRE); 黑/白: 0.001 Lux (IR LED開啟)
彩色到黑白模式	ISP開關, 配置
機械紅外濾鏡切換	有
紅外線靈敏度範圍	700-1100nm
紅外線	智能型 IR LED x 8 (850 nm)
紅外燈照射距離	200公尺
電子快門	1/5-1/32000 秒 (手動模式); 1/5-1/32000 秒 (自動模式)

水平分辨率(電視線)	1800 電視線
信噪比	75 dB

### 鏡頭

焦距	變焦, f4.5-148.5毫米
光圈	F1.55-F5.0
縮放比例	33x 光學變焦, 16x 數位變焦
Zoom Speed	2.7 秒 (廣長焦)
變焦應用	攝影機安裝, 按事件自動縮放, 手動操作
光圈	DC 光圈
焦點	自動對焦
鏡頭卡口	板載
水平可視角度	69.3° - 3°
垂直視角	38° - 1.7°
Overview, Zoom and Tracking (OZT) technology	有 (Pair of intelligent speed dome camera with B511A, B59A, B74A and B76A hemispheric camera)

### PTZ

Scan Panning / Tilting Speed	0.16° - 32°/秒, 0.16° - 16°/秒
手動平移 / 傾斜速度	0.16° - 54.4°/秒, 0.16° - 27.2°/秒
預設點準度(平移/傾斜)	0.16° - 300°/秒, 0.16° - 150°/秒
旋轉攝影範圍	360° 無限平移
傾斜範圍	-20°~200°
PTZ控制	遠程手動控制, 速度控制, Select box to PTZ, 256 預設點, 10 預置位置輪巡, 自動掃描
Preset Accuracy (Panning/Tilting)	±0.265°/±0.265°
絕對位置	有
平移, 傾斜或變焦	Visca, Pelco-D, Pelco-P, ACTi URL 命令

### 影像

分辨率	H.264 (Baseline/ Main/ High profile), MJPEG
最大幀率和分辨率	60 幀 1920 x 1080 60 幀 1280 x 720 30 幀 640 x 480 30 幀 320 x 240
高幀模式	支援
多串流	提供3串流 基於視訊解析度、壓縮格式和幀速率配置條件下
位元率	128Kbps - 12Mbps* (每一個串流)
比特率模式	常數, 可變動
寬動態	超高級 寬動態 (145 dB)
影像升級	白平衡, 亮度, 對比, 銳利度, 自動增益控制, 無閃爍, 數位影像穩定 (DIS, EIS), 除霧
數位降噪	2D + 3D DNR
隱私遮擋	20 配置 3D 隱蔽遮罩

文字疊加	Yes
圖片覆蓋	Yes
內建分析	Basic Face Detection, 物體移動偵測, 破壞偵測, 衝擊偵測, PTZ自動追蹤, 電子圍籬, 進入區域, 遺失物偵測, 遺留物偵測, 遊蕩偵測
影像管理系統分析	物件計數, 人流計算, 人臉偵測, 物體移動偵測, 轉向偵測, 電子圍籬, 進入區域, 遺失物偵測, 遺留物偵測, 煙霧偵測, 動線熱區, 停留時間, 方向檢測, 自動車牌辨識, 排隊管理, (需要PC- 基礎或獨立 IVS 或自動車牌識別服務器)
影像定位	翻動, 鏡面
IVS 效能	Certain algorithms may require more computing power, which may limit the number of algorithms that can be concurrently used in the camera. Please test the actual performance before using in a project.

## 音頻

音頻類型	雙向, 外部音源輸入, 外部音源輸出
音源壓縮	8 kHz, 16 位元編碼, Mono, 脈衝編碼調變, G.711

## 網路

網路協議與服務	IPv4/v6, TCP, UDP, DHCP, PPPoE, HTTP, HTTPS, DNS, DDNS, NTP, RTP, RTSP, RTCP, SMTP, FTP, IGMP, ICMP, ARP, Bonjour, UPnP, QoS, SNMP, IEEE 802.1X
網路埠口	1 x 乙太網路(10/100 Base-T), RJ-45 pigtail 連接埠
安全	IP 位址過濾, HTTPS 加密, 密碼保護用戶級別, 匿名登入, IEEE 802.1X 網路門禁控制, Standard IoT Security (anti-hacking, anti-malware)

## Video Analytics

分析源類型	影像
元數據準確性	標準

## 事件功能

事件觸發	影像移動偵測(10個區域), 透過數位輸入連接外部設備, 聲音的檢測, 智能事件偵測, 影像串流中斷, System log buffer overrun, Remove system log, Logon events (Login Failure, Login Success, Block an Account)
事件回應	通知控制中心, 轉到雲台預置點或預置位巡視, 變更攝影機的設置, 指揮其他設備, E-mail 通知與快照, 播放聲音檔, 推播通知至行動裝置, Save video to local storage, Upload video to NVR server, 上傳影像或快照到FTP伺服器, 透過數位輸出觸發外部設備

## 系統

系統監測	CPU 使用率, 記憶體使用量, 網路流量資訊 (內建網頁伺服器, 提供API讀取系統狀態)
System Log	支援
看門狗	支援

## 整合

整合解決方案	與ACTi的軟體完全相容
軟體開發套件	有
GPS 位置	手動設定
Edge Recording	支援 (integration with NVR by ONVIF Profile G or proprietary protocol)**
ONVIF 標準	有, Profile S, Profile G, Profile T, Profile Q, Profile M* (讓未來的韌體可順利更新)
GB28181 Compliant	有

支援瀏覽器	IE 11, Google Chrome, Microsoft Edge, Apple Safari
韌體線上更新功能	有

## 界面

音源介面	Cable線帶有3.5mm耳機接口
本地儲存	MicroSDHC, MicroSDXC Memory Card Slot (card not included, up to 256GB, Kingston or Sandisk only)
數位輸入/輸出	4/2
Operating Button	復位按鈕

## 一般

電力來源	直流電(DC) 48V, 交流電(AC) 24V, High PoE 60W
電源消耗	50 W (PoE, 加熱器 風扇和紅外線開啟), 62 W (交流電(AC), 加熱器 風扇和紅外線開啟)
重量	3112公克 (6.86磅)
尺寸	(Ø x H): 170毫米 x 260毫米 (6.69" x 10.23")
防護罩等級	防水 (IP66), 防暴金屬遮罩 (IK10), 內建除濕器, 防刮防水鏡頭玻璃
Corrosion Protection	訂購號碼: I98-K1. Chassis corrosion resistance at the seashore approximately 10 years.
綁定配件	High PoE injector (USA only) or Power Adapter (AC 24V for regions outside the USA)
安裝方式	Gang Box, Pendant, Converter for NPT Standard Mounts, Wall Mount, Pole Mount, Corner Mount
風扇	有
加熱器	有
除濕器	有
起始溫度	-40溫度(攝氏) ~ 55溫度(攝氏) (-40溫度(華氏) ~ 131溫度(華氏)) 在30分鐘內
操作溫度	-40溫度(攝氏) ~ 55溫度(攝氏) (-40溫度(華氏) ~ 131溫度(華氏))
操作濕度	10% - 85% 相關濕度
認證	CE Class B, FCC Class B, EAC, BIS, IP66, NEMA 4X, IK10 (metal casing), UL Listed (UL 60950-1), 臺灣資安標準 2 級標章 (TCA)
實時時鐘 (RTC)	有
保固	3 年 (PTZ功能在24小時持續轉動下, 保固期為一年). 有關延長保固期, 請見 <a href="http://www.acti.com/support/warranty">http://www.acti.com/support/warranty</a>
備註	** Edge Recording function is integrated with NVR 3 Corporate / NVR 3 Business / INR / GNR series.

### ▶ 產品圖片



- 1 電源指示燈
- 2 復位按鈕
- 3 記憶卡插槽
- 4 音頻輸出
- 5 音頻輸入
- 6 數位輸入/輸出
- 7 AC 24V Power Input
- 8 網路埠口



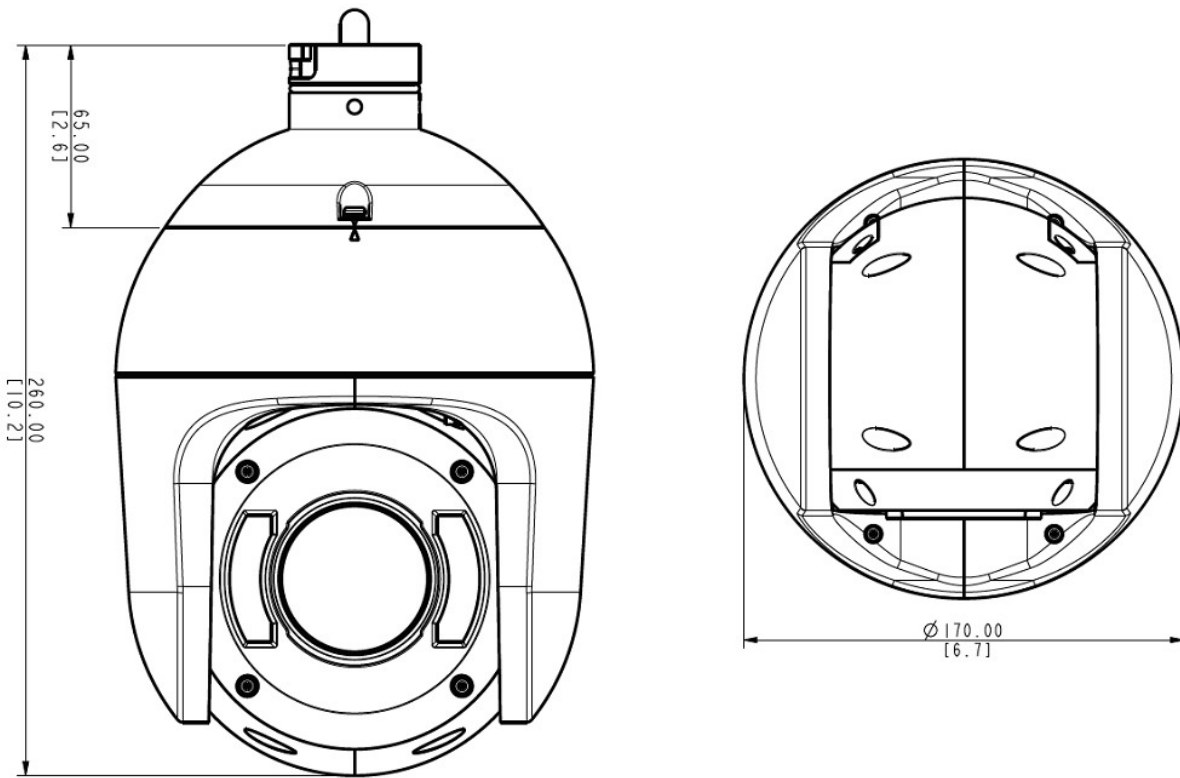









### ▶ 尺寸圖片



單位: 毫米 [英寸]



## ▶ 相關產品

### 安裝配件 - 攝影機支架



PMAX-0102		Straight Tube
PMAX-0103		Straight Tube with Bracket
PMAX-0104		Extension Tube
PMAX-0302		Gooseneck with Bracket
PMAX-0303		Gooseneck
PMAX-0312		PTZ Wall Mount for Outdoor PTZ / Speed Dome (except KCM-8211 & TCM-6630)
PMAX-0402		Corner Mount
PMAX-0503		Pole Mount (for PMAx-0102, PMAx-0312, PMAx-0313, PMAx-0314, PMAx-0702, PMAx-1106, PMAx-1107), supports 5.25" to 8.5" Poles
PMAX-0505		Pole Mount (for B4x, B41x, E44, E45, E46, E48, E44A, E45A, E46A, E41x, I4x, PMAx-0312, PMAx-0313, PMAx-0314, PMAx-0330), supports 2" to 3" Poles
PMAX-0702		Junction Box for PTZ and Dome Cameras
PMAX-0807		Gangbox Converter (for PMAx-0102, PMAx-0312, PMAx-0313, PMAx-0314, PMAx-0321), supports Two-Gang Boxes
PMAX-0808		Converter Ring, 1.5" NPT for Third-Party Mounting Accessories

**備註:** 某些安裝附件可能需要額外的附件才能安裝。請訪問網站了解更多信息 - [www.acti.com/mountingselector](http://www.acti.com/mountingselector)

### 電源供給配件 - 電源變壓器

PPBX-0005		Power Adapter AC 220V for TCM-6630
PPBX-0008		Power Adapter AC 100~240V, with universal connectors for PLED-0203~PLED-0205

### 電源供給配件 - PoE 供電器

PPOE-0102		High PoE Injector IEEE 802.3at compliant, AC 100~240V, with universal connectors (for I93~I910, KCM-8211)
PPOE-0103		High PoE Injector, Single-port, 60W Gigabit Midspan, 4-Pairs, 802.3at Compliant, AC 100~240V, with universal connectors (for, I93~I910, I915, B915~B917, B922, B928, B945, B949, A950, A951)

PPOE-0104



High PoE Injector, Single-port, 10/100/1000Mbps 60W, 4-Pairs, 802.3at Compliant, AC 100~240V, with universal connectors (for, I93~I910, I915, B915~B917, B922, B928, B945, B949, A950, A951)

### 網路和存儲周邊設備 - 數據交換機

PPSW-0102



PLANET FGSD-1011HP 8-Port 802.3at PoE Switch (PoE Budget 120W)

PPSW-0105



PLANET GS-4210-8P2C 8-Port Gigabit 802.3at Managed PoE Switch (PoE Budget 120W)

PPSW-1101



PLANET GS-4210-24PL4C 24-Port Gigabit 802.3at Managed PoE Switch (PoE Budget 440W)

PPSW-3100



PLANET FGSW-1816HPS 16-Port 802.3at PoE Switch (PoE Budget 220W)

### Extenders - PoE擴展器

PPEX-0100



Veracity OUTREACH Max Power over Ethernet (PoE) Extender

### Extenders - PoE over Coaxial Extender Kit

PPOC-0100



Planet LRP-101C-KIT Power over Coax Adapter Kit

### 音頻設備 - 麥克風

PMIC-0100



Active Microphone Omnidirectional for all Cameras with Line-in Audio

### Illuminators - IR LED 照明器

PLED-0200



SPINLUX (SL-A2IRXX10-24CL) IR Illuminator 10° Angle with 120 m approx. range

PLED-0201



SPINLUX (SL-A2IRXX25-24CL) IR Illuminator 25° Angle with 50 m approx. range